



Articulating Keyboard Systems

Articulating Keyboard Systems

EB-01 EcoBoard 01 Specifications



EB-01 EcoBoard 01

Legato Arm Mechanism

- Lift n' lock™ "leverless" height adjustment
- 8.88" height adjustment range of 2.38" above and 6.5" below worksurface
- Innovative dial tilt makes angle adjustment quick and easy - angle adjustment +10° to -20°
- Tilt and height indicator displays present keyboard position
- Cable management system
- Low profile arm mechanism and tray head give the arm a sleek, thin design and maximizes knee clearance
- 21" smooth glide storage track
- 360° swivel mount

Platform/Mouse

- 26" high density polyethylene platform with textured finish
- 45% recycled content by weight (post industrial content)
- 100% recyclable
- Removable 25.5" GelFoam palm/wrist support
- Mouse fence with cable manager
- Anti-skid pads keep keyboard in place
- Mouse friendly surface



100% recyclable
45% recycled content by weight

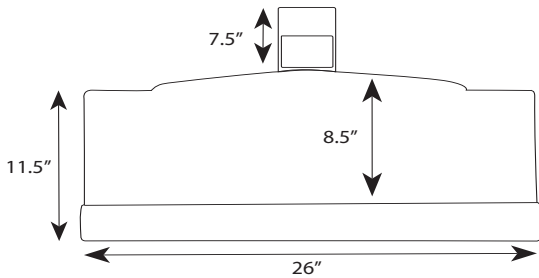

Additional Features

- Complies to BIFMA/HFES, 100-2007 standards
- Suitable for right or left handed users



eco-friendly design



EB-02 EcoBoard 02 Specifications



EB-02 EcoBoard 02

Legato Arm Mechanism

- Lift n' lock™ "leverless" height adjustment
- 8.88" height adjustment range of 2.38" above and 6.5" below worksurface
- Innovative dial tilt makes angle adjustment quick and easy - angle adjustment +10° to -20°
- Tilt and height indicator displays present keyboard position
- Cable management system
- Low profile arm mechanism and tray head give the arm a sleek, thin design and maximizes knee clearance
- 21" smooth glide storage track
- 360° swivel mount

Platform/Mouse

- 20" high density polyethylene platform with textured finish
- Ergonomic adjustment of tilt, swivel and height adjustable mouse support
- 45% recycled content by weight (post industrial content)
- 100% recyclable
- Removable 19" GelFoam palm/wrist support
- Mouse fence with cable manager
- Anti-skid pads keep keyboard in place
- Mouse friendly surface



100% recyclable
45% recycled content by weight

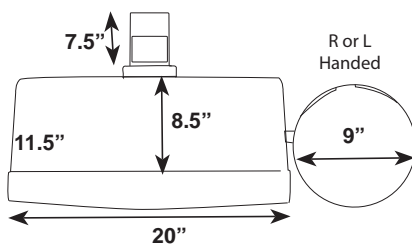

Additional Features

- Complies to BIFMA/HFES, 100-2007 standards
- Suitable for right or left handed users



eco-friendly design



Articulating Keyboard Systems

CA-01 Compact Specifications



CA-01 Compact

Legato Arm Mechanism

- Lift n' lock™ "leverless" height adjustment
- 8.88" height adjustment range of 2.38" above and 6.5" below worksurface
- Innovative dial tilt makes angle adjustment quick and easy - angle adjustment +10° to -20°
- Tilt and height indicator displays present keyboard position
- Cable management system
- Low profile arm mechanism and tray head give the arm a sleek, thin design and maximizes knee clearance
- 17" smooth glide storage track
- 360° swivel mount

Platform/Mouse

- Manufactured from graphite Phenolic
- Tray length - 24.25", Width 8.33", and depth .25" thick
- User installable self-adhesive anti-slip pads
- Plug in Gel-Foam palm rest 18" long x 1.7" deep x 0.63" high, which is removable for cleaning
- Removable mouse fence with built-in cable manager
- Strong and durable with decorative finish
- Less storage space required
- Ample room for keyboard and mouse

Additional Features

- Complies to BIFMA/HFES, 100-2007 standards
- Suitable for right or left handed users



PM-01 Prima Specifications



PM-01 Prima

Legato Arm Mechanism

- Lift n' lock™ "leverless" height adjustment
- 8.88" height adjustment range of 2.38" above and 6.5" below worksurface
- Innovative dial tilt makes angle adjustment quick and easy - angle adjustment +10° to -20°
- Tilt and height indicator displays present keyboard position
- Cable management system
- Low profile arm mechanism and tray head give the arm a sleek, thin design and maximizes knee clearance
- 21" smooth glide storage track
- 360° swivel mount

Platform/Mouse

- Compact 18.88" wide x 10.28" deep x 0.81" thick keyboard tray platform
- Removable foam wrist rest facilitates the use of larger wave type keyboards
- Integral anti-skid strips prevent keyboard movement while typing
- Flip-up document holder
- Cable management
- Integral steel pull handle
- Aesthetically pleasing design molded from durable ABS resin

Additional Features

- Complies to BIFMA/HFES, 100-2007 standards
- Suitable for right or left handed users

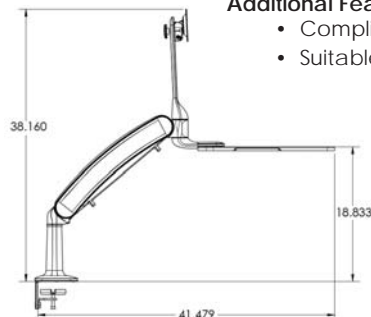

Articulating Keyboard Systems

JB-01 Jitterbug Specifications

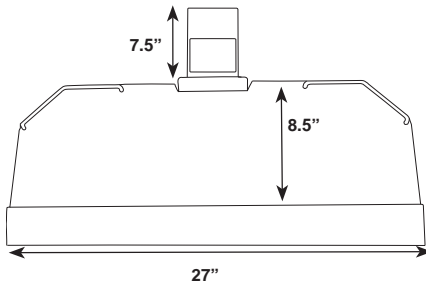

JB-01 Jitterbug

Legato Arm Mechanism

- Lift n' lock™ "leverless" height adjustment
- 8.88" height adjustment range of 2.38" above and 6.5" below worksurface
- Innovative dial tilt makes angle adjustment quick and easy - angle adjustment +10° to -20°
- Tilt and height indicator displays present keyboard position
- Cable management system
- Low profile arm mechanism and tray head give the arm a sleek, thin design and maximizes knee clearance
- 21" smooth glide storage track
- 360° swivel mount

Platform/Mouse

- 27" platform
- Mouse and keyboard on the same level
- Removable 26" GelFoam palm/wrist support
- Anti-skid pads keep keyboard in place
- Mouse fence with cable manager
- Mouse friendly surface

Additional Features

- Complies to BIFMA/HFES, 100-2007 standards
- CGSB approved
- Suitable for right or left handed users



JV-01 Jive Specifications

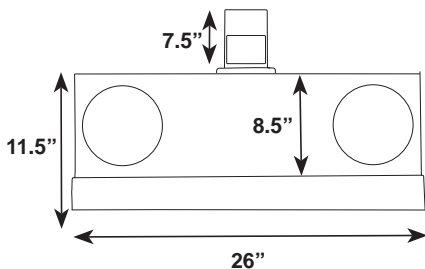

JV-01 Jive

Legato Arm Mechanism

- Lift n' lock™ "leverless" height adjustment
- 8.88" height adjustment range of 2.38" above and 6.5" below worksurface
- Innovative dial tilt makes angle adjustment quick and easy - angle adjustment +10° to -20°
- Tilt and height indicator displays present keyboard position
- Cable management system
- Low profile arm mechanism and tray head give the arm a sleek, thin design and maximizes knee clearance
- 21" smooth glide storage track
- 360° swivel mount

Platform/Mouse

- 26" steel platform
- Mouse and keyboard on the same level
- Removable 26" GelFoam palm/wrist support
- Anti-skid pads keep keyboard in place
- Mouse fence with cable manager
- Mouse friendly surface

Additional Features

- Complies to BIFMA/HFES, 100-2007 standards
- Suitable for right or left handed users



Articulating Keyboard Systems

SA-01 Salsa Specifications

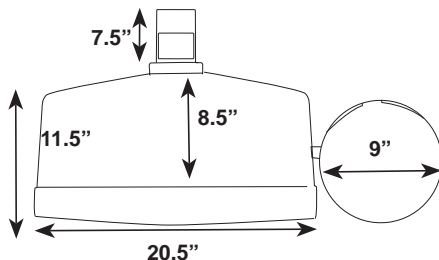

SA-01 Salsa

Legato Arm Mechanism

- Lift n' lock™ "leverless" height adjustment
- 8.88" height adjustment range of 2.38" above and 6.5" below worksurface
- Innovative dial tilt makes angle adjustment quick and easy - angle adjustment +10° to -20°
- Tilt and height indicator displays present keyboard position
- Cable management system
- Low profile arm mechanism and tray head give the arm a sleek, thin design and maximizes knee clearance
- 21" smooth glide storage track
- 360° swivel mount

Platform/Mouse

- 20.5" phenolic platform
- 9" separate tilt and swivel mouse platform **mounts R or L**
- Removable 19" GelFoam palm/wrist support
- Anti-skid pads keep keyboard in place
- Mouse fence with cable manager
- Mouse friendly surface

Additional Features

- Complies to BIFMA/HFES, 100-2007 standards
- CGSB approved
- Suitable for right or left handed users



BIFMA
TESTED

MB-01 Mambo Specifications

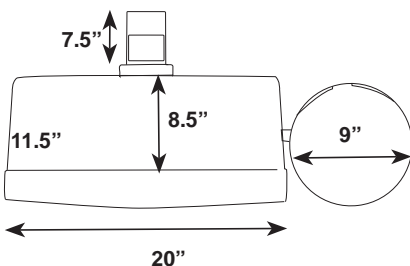

MB-01 Mambo

Legato Arm Mechanism

- Lift n' lock™ "leverless" height adjustment
- 8.88" height adjustment range of 2.38" above and 6.5" below worksurface
- Innovative dial tilt makes angle adjustment quick and easy - angle adjustment +10° to -20°
- Tilt and height indicator displays present keyboard position
- Cable management system
- Low profile arm mechanism and tray head give the arm a sleek, thin design and maximizes knee clearance
- 21" smooth glide storage track
- 360° swivel mount

Platform/Mouse

- 20" steel platform
- 9" separate tilt and swivel mouse platform **mounts R or L**
- Removable 19" GelFoam palm/wrist support
- Anti-skid pads keep keyboard in place
- Mouse fence with cable manager
- Mouse friendly surface

Additional Features

- Complies to BIFMA/HFES, 100-2007 standards
- Suitable for right or left handed users



BIFMA
TESTED

Articulating Keyboard Systems

HS-01 Hustle Specifications

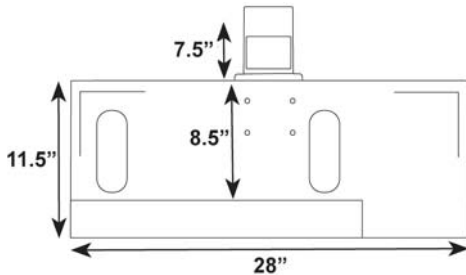

HS-01 Hustle

Legato Arm Mechanism

- Lift n' lock™ "leverless" height adjustment
- 8.88" height adjustment range of 2.38" above and 6.5" below worksurface
- Innovative dial tilt makes angle adjustment quick and easy - angle adjustment +10° to -20°
- Tilt and height indicator displays present keyboard position
- Cable management system
- Low profile arm mechanism and tray head give the arm a sleek, thin design and maximizes knee clearance
- 21" smooth glide storage track
- 360° swivel mount

Platform/Mouse

- 28" phenolic platform
- Mouse and keyboard on the same level
- Includes mouse fence with cable manager
- Standard with 26" removable GelFoam palm/wrist support
- Anti-skid pads keep keyboard in place
- Mouse friendly surface

Additional Features

- Complies to BIFMA/HFES, 100-2007 standards
- Suitable for right or left handed users
- CBSB approved



HH-03 HipHop Specifications

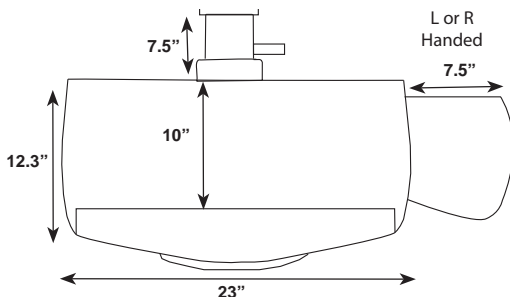

HH-03 HipHop

Legato Arm Mechanism

- Lift n' lock™ "leverless" height adjustment
- 8.88" height adjustment range of 2.38" above and 6.5" below worksurface
- Innovative dial tilt makes angle adjustment quick and easy - angle adjustment +10° to -20°
- Tilt and height indicator displays present keyboard position
- Cable management system
- Low profile arm mechanism and tray head give the arm a sleek, thin design and maximizes knee clearance
- 21" smooth glide storage track
- 360° swivel mount

Platform/Mouse

- 23" durable ABS plastic tray
- Mouse surface extends 7.5" outside tray on either side
- Removable 19" GelFoam wrist rest
- Comfort grip handle to extend or store keyboard
- Three position forward indexing mouse surface
- Includes mouse fence with cable manager
- Anti-skid pads keep keyboard in place
- Mouse friendly surface

Additional Features

- Complies to BIFMA/HFES, 100-2007 standards
- Suitable for right or left handed users



Articulating Keyboard Systems

SM-01 Samba Specifications

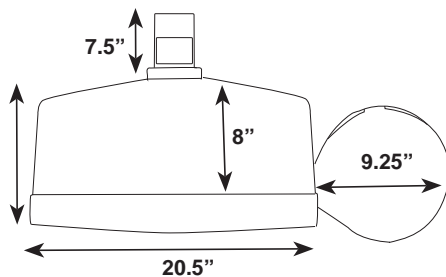

SM-01 Samba

Legato Arm Mechanism

- Lift n' lock™ "leverless" height adjustment
- 8.88" height adjustment range of 2.38" above and 6.5" below worksurface
- Innovative dial tilt makes angle adjustment quick and easy - angle adjustment +10° to -20°
- Tilt and height indicator displays present keyboard position
- Cable management system
- Low profile arm mechanism and tray head give the arm a sleek, thin design and maximizes knee clearance
- 17" smooth glide storage track
- 360° swivel mount

Platform/Mouse

- 20.5" phenolic platform
- 9" separate mouse platform
- Removable 19" GelFoam palm/wrist support
- Anti-skid pads keep keyboard in place
- Mouse fence with cable manager
- Mouse friendly surface

Additional Features

- Complies to BIFMA/HFES, 100-2007 standards
- Suitable for right or left handed users



JZ-02 Jazz Specifications

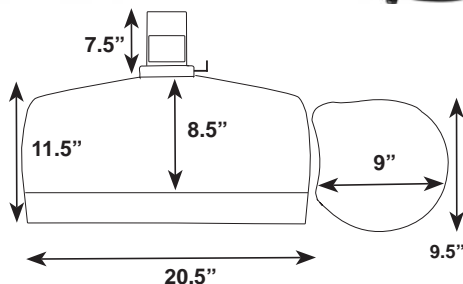

JZ-02 Jazz

Legato Arm Mechanism

- Lift n' lock™ "leverless" height adjustment
- 8.88" height adjustment range of 2.38" above and 6.5" below worksurface
- Innovative dial tilt makes angle adjustment quick and easy - angle adjustment +10° to -20°
- Tilt and height indicator displays present keyboard position
- Cable management system
- Low profile arm mechanism and tray head give the arm a sleek, thin design and maximizes knee clearance
- 21" smooth glide storage track
- 360° swivel mount

Platform/Mouse

- 20.5 phenolic platform
- Tilt, swivel and height adjustable mouse support **mounts R or L**
- Mouse support can be clamped anywhere on keyboard support
- Removable 20" GelFoam palm/wrist support
- Anti-skid pads keep keyboard in place
- Mouse fence with cable manager
- Mouse friendly surface

Additional Features

- Complies to BIFMA/HFES, 100-2007 standards
- Suitable for right or left handed users



Articulating Keyboard Systems

MN-01 Minuet Specifications



MN-01 Minuet

Features

- Simultaneous manual height and tilt adjustment
- Spring-assisted to help counter balance keyboard and tray weight
- Low profile design
- 6" height adjustment range of 1" above and 5" below worksurface
- +15° to -15° tilt adjustment
- 360° swivel
- Swivel mouse tray with cord management
- 17" smooth glide storage track

Platform/Mouse

- 21" Platform
- Mouse/cord management rails (right or left hand use)
- 9" Diameter mouse friendly surface

Additional Features

- Meets or exceeds BIFMA standards
- Adaptable for right or left handed users
- Low profile mechanism and platform maximizes knee clearance

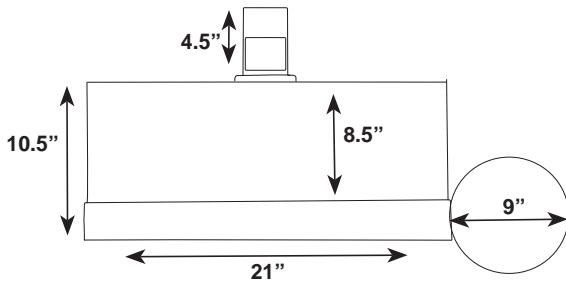

JB-JR Jitterbug JR Specifications



JB-JR Jitterbug JR

Mechanism

- Tilt n' set "leverless" height adjustment
- Height adjustment range of 7" (2" above to 5" below work surface)
- Lever activated +5° or -15° angle adjustment
- Multi position angle adjustment lever

Platform/Mouse

- 27" platform
- Mouse and keyboard on the same level
- 26" removable GelFoam palm/wrist support
- Mouse/cord management rails (right or left hand use)
- Anti-skid pads keep keyboard in place
- Mouse friendly surface

Additional Features

- Meets or exceeds BIFMA standards
- Adaptable for right or left handed users
- Low profile mechanism and platform maximizes knee clearance

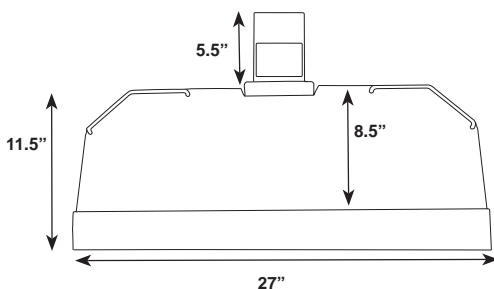

Articulating Keyboard Systems

AKT-4M Twist Specifications

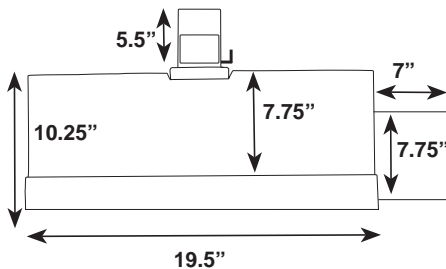

AKT-4M Twist

Mechanism

- Twist knob height/tilt adjustment
- Height adjustment range of 5" below the work surface

Platform/Mouse

- 20" steel platform
- Separate tiltable mouse
- 19" Gel palm/wrist support
- Anti-skid tray surface
- Mouse friendly surface

Track

- 18" smooth glide storage track
- 360° swivel mount

Additional Features

- Meets or exceeds BIFMA standards
- Adaptable for right or left handed users
- Low profile mechanism and platform maximizes knee clearance



AKT-1M Rumba Specifications

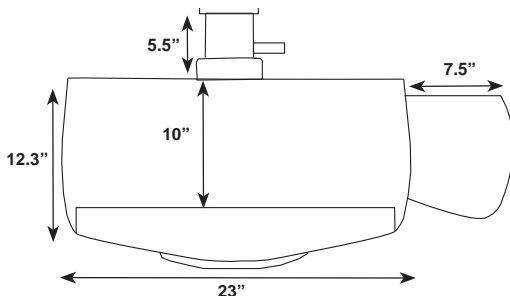

AKT-1M Rumba

Mechanism

- Twist knob height/angle adjustment
- Height adjustment range of 5" below worksurface
- Angle adjustment of +/- 15°

Platform/Mouse

- 23" durable ABS plastic tray in a black finish
- Extendable mouse surface extends 7.5" outside tray
- 19" Gelfoam™ removable, snap-in wrist rest
- Comfort grip handle to extend or store keyboard
- Forward indexing mouse surface with three positions
- Built-in cable management and fence
- Indexing mouse friendly surface

Track

- 17" low profile smooth glide track
- 360° swivel mount

Additional Features

- Meets or exceeds BIFMA standards
- Suitable for right or left handed users
- Low profile mechanism and platform maximizes knee clearance

